

Številka modela:
2312-127-84

ESENA

2D 40

Tip
127

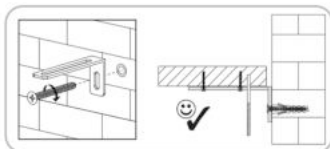
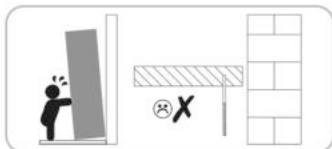
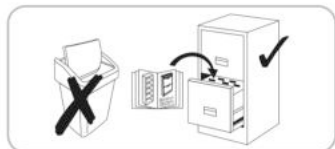
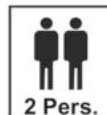
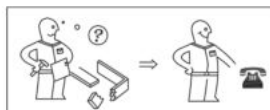
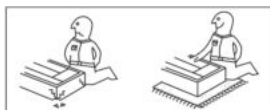
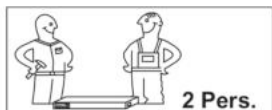

Ø8

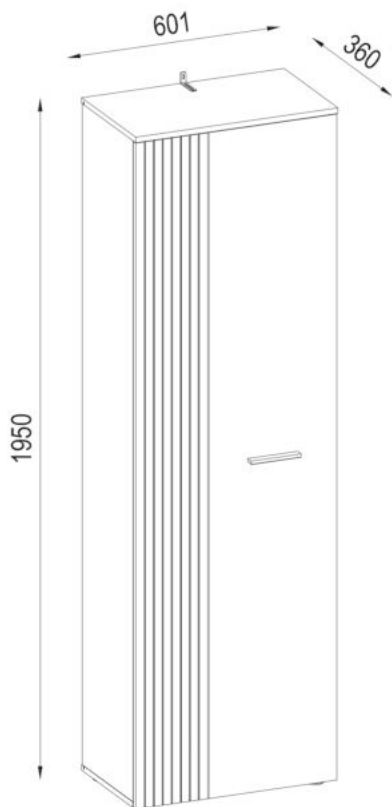

- trdno pritegniti
- vtisniti
- izmeriti
- vtisniti
- bevern
- Otocte - obratne

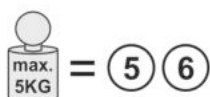
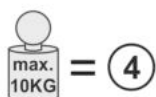

A	B (mm)		C	D
1	1898	340	16	x1 2/2
2	1898	340	16	x1 2/2
3	601	360	16	x1 1/2
4	601	340	16	x1 1/2
5	567	323	16	x1 1/2
6	566	315	16	x4 1/2
7	1913	582	2,5	x1 2/2

A	B (mm)		C	D
8	1911	214	16	x1 2/2
9	1911	380	16	x1 2/2
B1				1/2

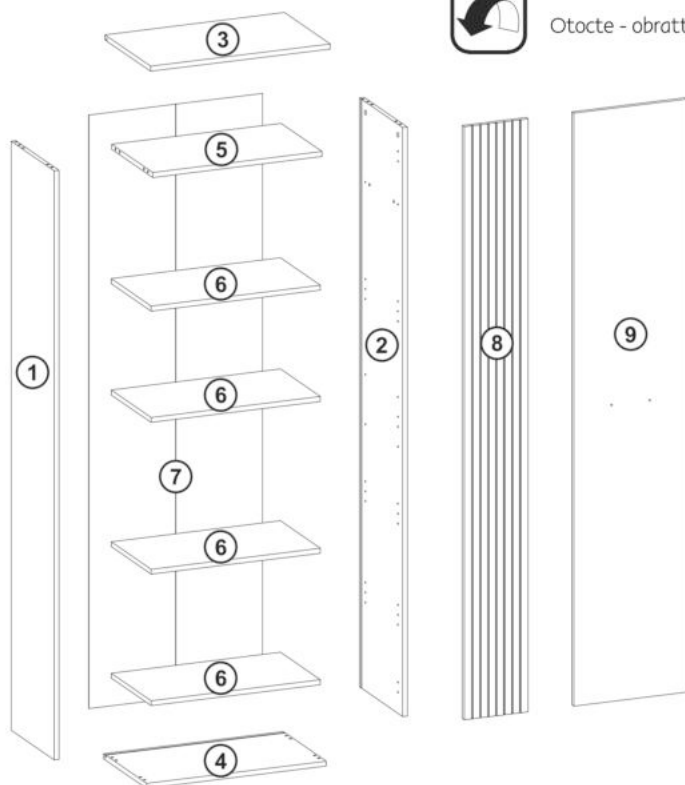

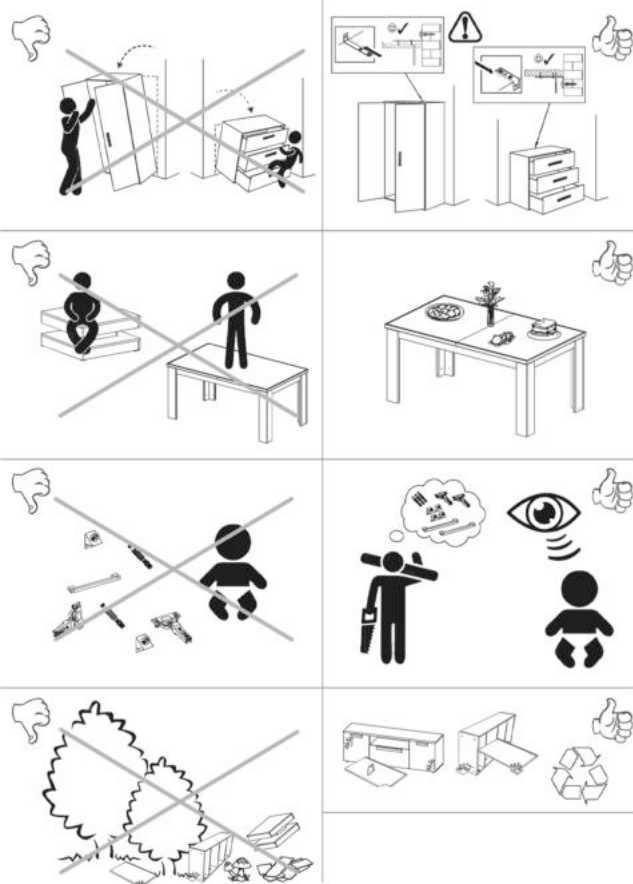

A1 15x12 x8	C2 44mm x8	B2 8x30 x12
FA1 4mm x1	F3 6,3x50 x4	O3 Ø18 x4
K6 Ø35 x6	J65 128/148 x1	O4 Ø18 x4
M1 10x10x15 x14	P14 45x20 x4	N1 Ø6 x16
Y36 75x32x15 x1	S13 300mm x1	DB2 4x25 x2
D25 4x25 x4	Y37 8x50 x1	Y35 4,2x65 x1
DA21 4,2x16 x4	D11 3,5x16 x14	D10 3x16 x4
		R10 Ø10 x4

Spoštovana stranka, zahvaljujemo se vam za nakup pohištva iz našega notranjega programa za izključno uporabo v zasebnih prostorih. Prosimo, da preverite popolnost obsega dobave in pred namestitvijo natančno preberete naslednje pomembne informacije ter jih shranite za poznejšo uporabo, tudi s strani tretjih oseb. Naše pohištvo je treba uporabljati v skladu s predpisi. Uporaba v nasprotju s predpisi lahko povzroči materialno škodo in v določenih okoliščinah tudi telesne poškodbe. Pohištvo ni igrača. Proizvajalec ali prodajalec ne prevzemata jamstva za škodo, ki nastane zaradi uporabe v nasprotju s predpisi ali nepravilnega ravnanja.

OPOZORILO: Otroci ali osebe z motnjami v duševnem razvoju se morajo ves čas izogibati delom pohištva, koničastim predmetom, majhnim delom in embalaži, saj obstaja nevarnost poškodb in/ali zadužitve.

MONTAŽA: Pri sestavljanju upoštevajte naša navodila za uporabo, delovanje, namestitvev ali montažo ter bodite posebej pozorni na opozorila in varnostna navodila. Neupoštevanje navodil lahko povzroči telesne poškodbe ali poškodbe pohištva/varnostne nevarnosti. Če imate kakršne koli težave pri namestitvi/montaži, se obrnite na našo servisno službo. Z veseljem vam bodo svetovali in pomagali. Namestitev lahko opravi le usposobljeno osebe. Ne prevzemamo nobene odgovornosti za škodo, če so na izdelku/delu/delah izdelka opravljene spremembe ali če so zamenjani ali uporabljeni deli/potrošni material, ki ne izvirajo od proizvajalca/prodajalca. Če so z blagom dobavljeni stenski pritrdilni elementi, kot so zatiči in vijaki, so ti namenjeni samo za uporabo na stenah iz trdnih in homogenih materialov. Pritrditev je tako dobra kot povezava med pritrditvijo in steno. Pred pritrditvijo morate preveriti primernost stene za stoječe in viseče pohištvo ter uporabiti le primerne pritrdilne elemente. Pred vsakim nameščanjem se prepričajte, da v prostoru za dobrodošlico ni električnih žic. Na koncu je za pritrditev stene odgovoren monter.

To velja tudi za vgradnjo električnih izdelkov in drugih gradbeno-tehničnih pripomočkov. Montažo/vgradnjo električnih izdelkov in drugih pomembnih gradbeno-tehničnih pripomočkov lahko izvaja le pooblaščen usposobljeno osebe. Vse električne in gradbeno-tehnične inštalacije morajo biti izvedene v skladu z veljavnimi standardi in varnostnimi predpisi v vaši državi. Pri svetlobnih virih uporabljajte le dovoljeno jakost osvetlitve. Neupoštevanje največjega števila vatov lahko povzroči nevarnost požara zaradi pregrevanja. Zaradi nevarnosti požara prekrivanje svetilk ni dovoljeno. Popolno delovanje pohištva je zagotovljeno le pri navpični in vodoravni namestitvi. Vrata so vnaprej nastavljena, vendar jih je mogoče glede na lokalne razmere ponovno nastaviti. Upoštevajte podatke o teži za največjo obremenitev. Na pohištvo se ne sme plezati. Ob nestrokovni uporabi se lahko pohištvo prevrne. Da bi to preprečili, je treba pohištvo vedno zavarovati pred prevrnitvijo. Pri preobremenitvi/preveliki obremenitvi (zlasti zaradi igranja otrok, ljudi, materialov ali drugih neprimerenih vplivov) obstaja nevarnost zloma in poškodb. Vse vijake in podpore priključne točke je treba po 5 do 6 tednih zategniti, da se zagotovi trajna stabilnost.



SKRB ZA POHIŠTVO—Da bi v našem izdelku uživali čim dlje, upoštevajte naša navodila za pravilno nego pohištva. Pri čiščenju uporabljajte čisto, suho in mehko bombažno krpo. Če pohištvo potrebuje temeljito čiščenje, lahko krpo navlažite z malo vode ali čistilom za pohištvo in nato očiščene dele posušite. Kovinske in steklene dele je najbolje očistiti s komercialno dostopnimi čistili za kovine in steklo v skladu z navodili na izdelku. Na čistilih mora biti jasno navedeno, da so primerna za čiščenje pohištva. Nikakor ne uporabljajte parnih čistil, kavstičnih sredstev, abrazivnih sredstev ali drugih izdelkov, katerih učinkov ne poznate. **POZOR:** Površine z visokim sijajem so ob dobavi zaščitene z zaščitno folijo. Folijo pustite na pohištvu, dokler ni popolnoma sestavljeno in očiščeno prahu. Predmete z visokim sijajem, s katerih je bila odstranjena zaščitna folija, lahko očistite in uporabite šele po 72 urah (čas za naknadno strjevanje na zunanjem zraku). Površin ne smete poškodovati z ostrimi predmeti in jih nikoli ne smete izpostavljati močni sončni svetlobi.

LIKVIDACIJA— Navodila za odstranjevanje odpadkov —

Za zaščito okolja odpadno embalažo odlagajte ločeno po vrstah v za to namenjene smetnjake/koše za recikliranje in je v nobenem primeru ne odlagajte v okolje. Poškodovano ali neuporabno pohištvo lahko pošljete v posebne zbirne centre za recikliranje posameznih delov. Rabljenega, a še vedno funkcionalnega pohištva ni treba takoj odstraniti. Podarite ga na primer dobrodelnim organizacijam. Želimo vam veliko veselja z novim pohištvom.

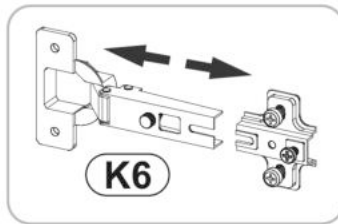
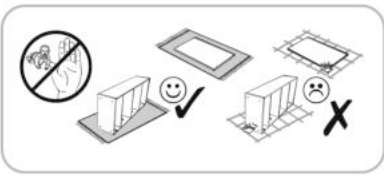
1

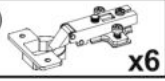

- A1** 15x12  x4
- C2** 44mm  x4
- B2** 8x30  x8
- K6** Ø35  x6

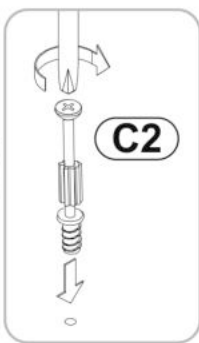
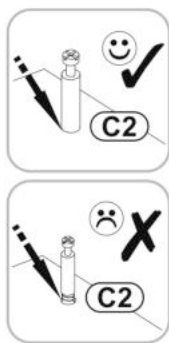
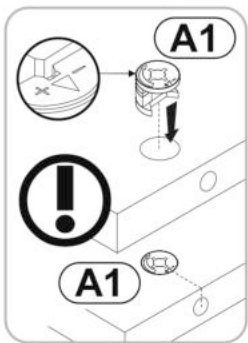
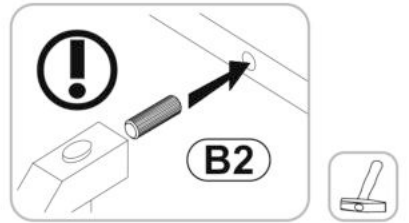
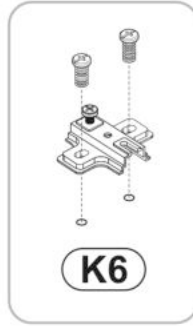
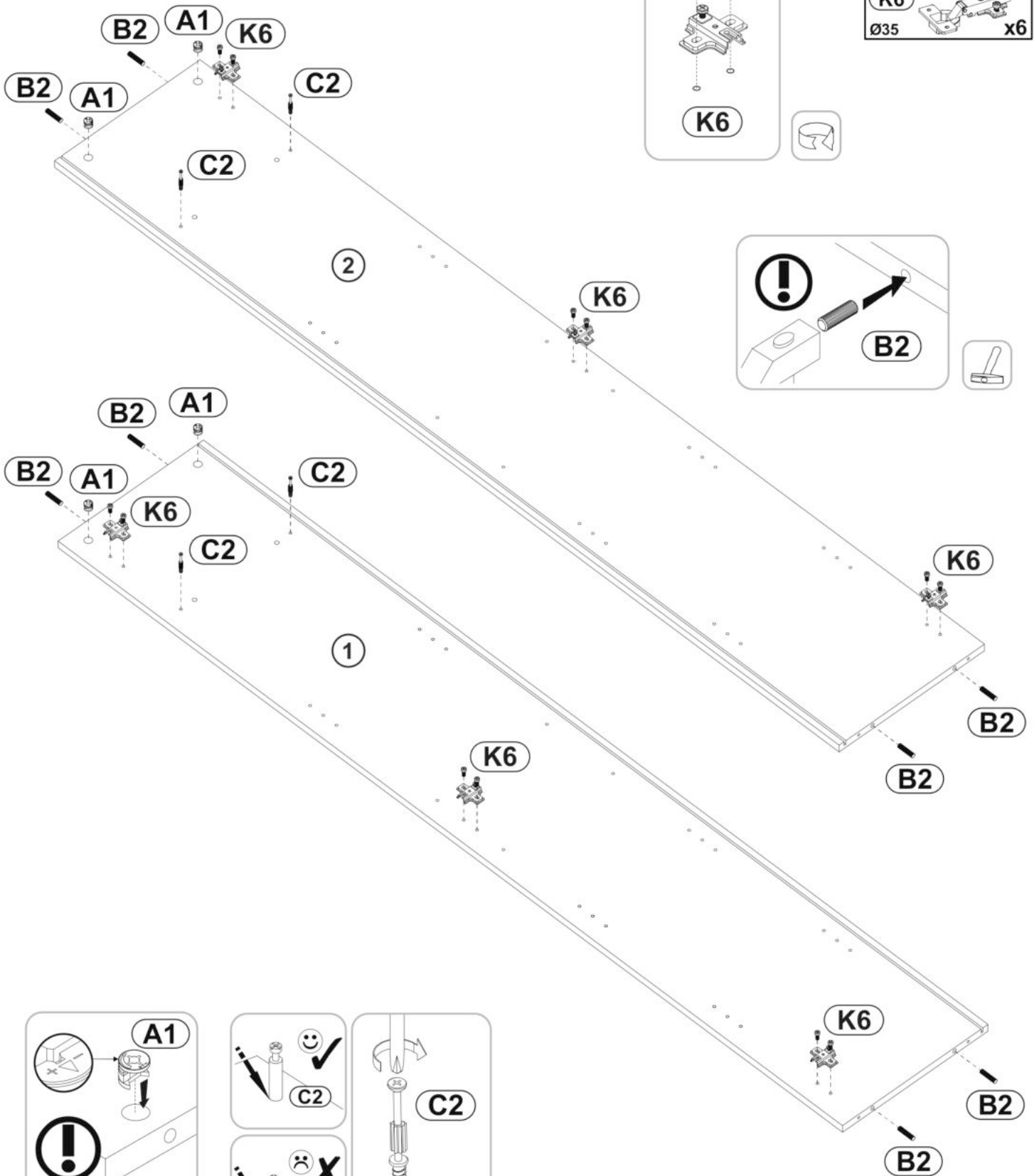

2

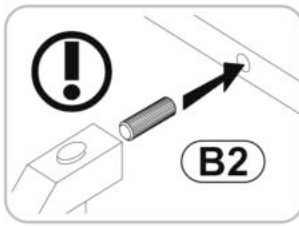
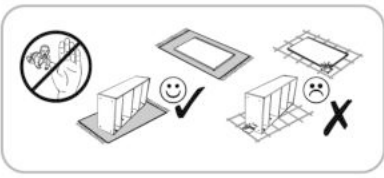

A1		x4
C2		x4
B2		x4
D10		x4
S13		x1

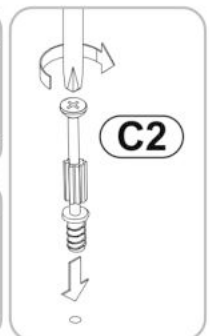
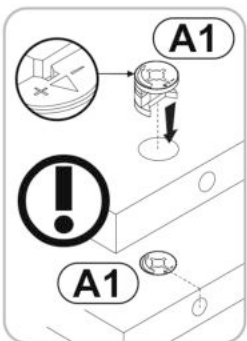
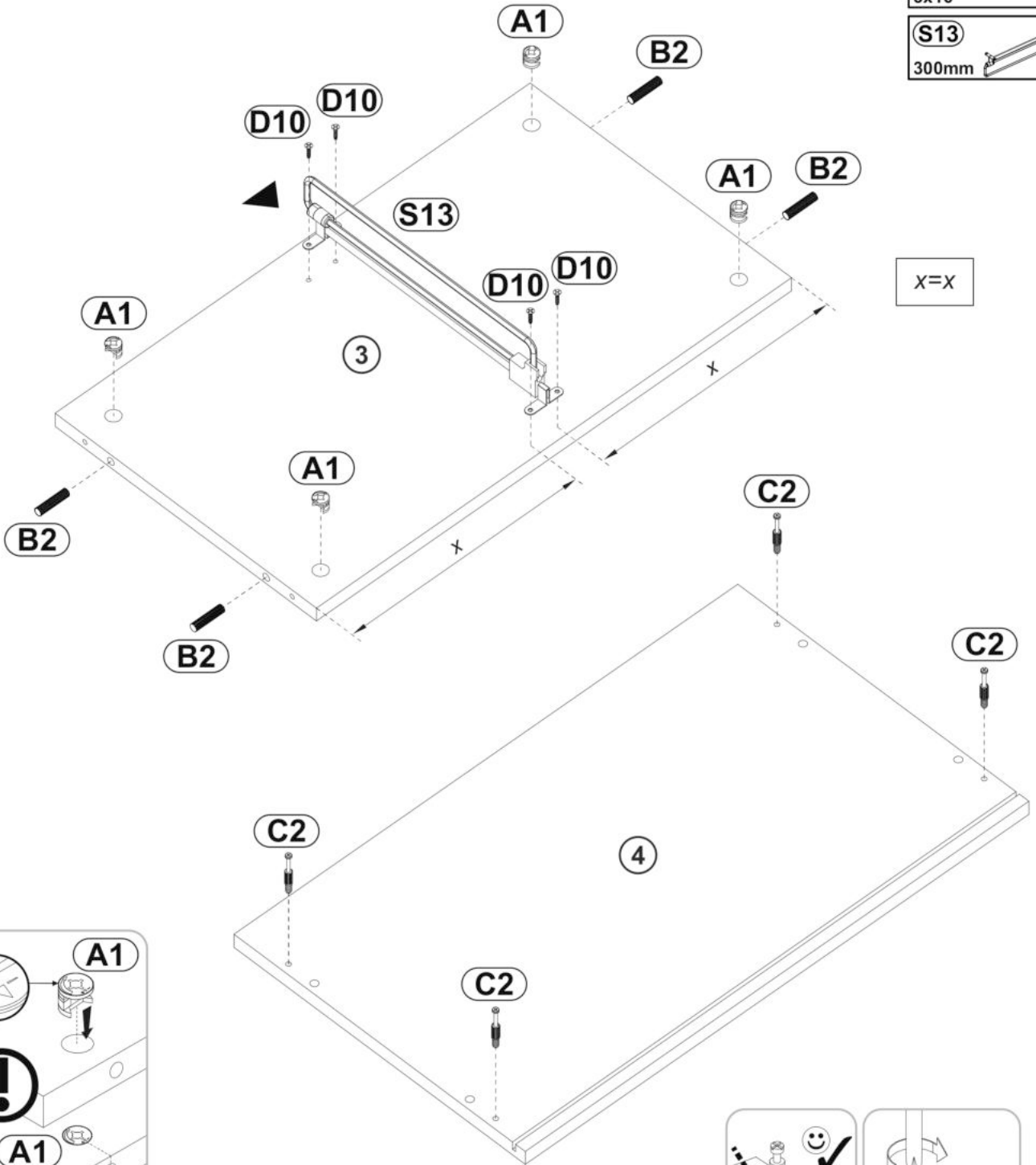

3

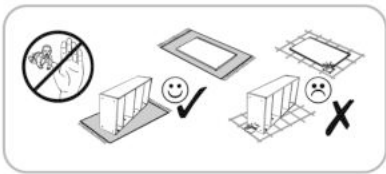

O3
Ø18  **x4**

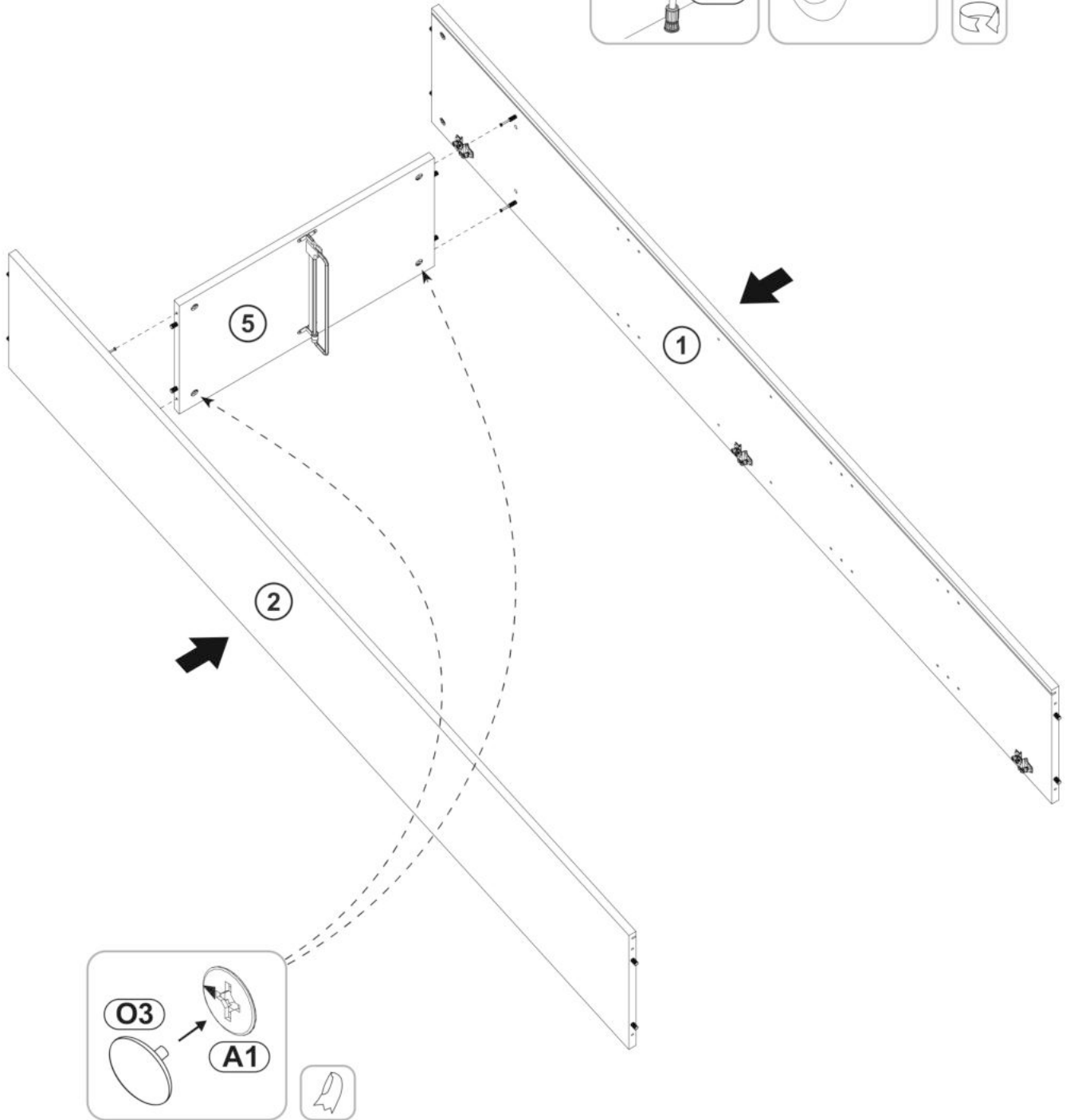
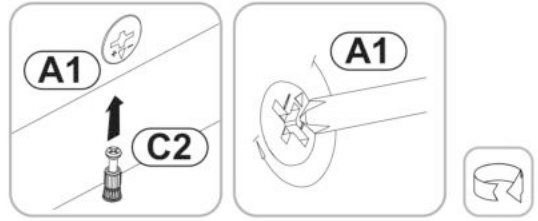

4

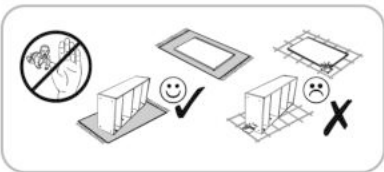

O4
Ø18 x4

A small illustration of a circular cam lock with a central pin.

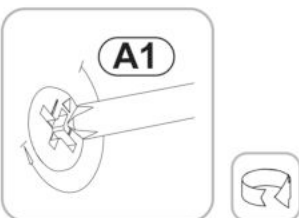
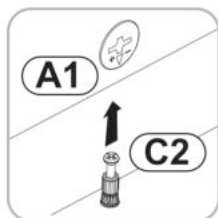
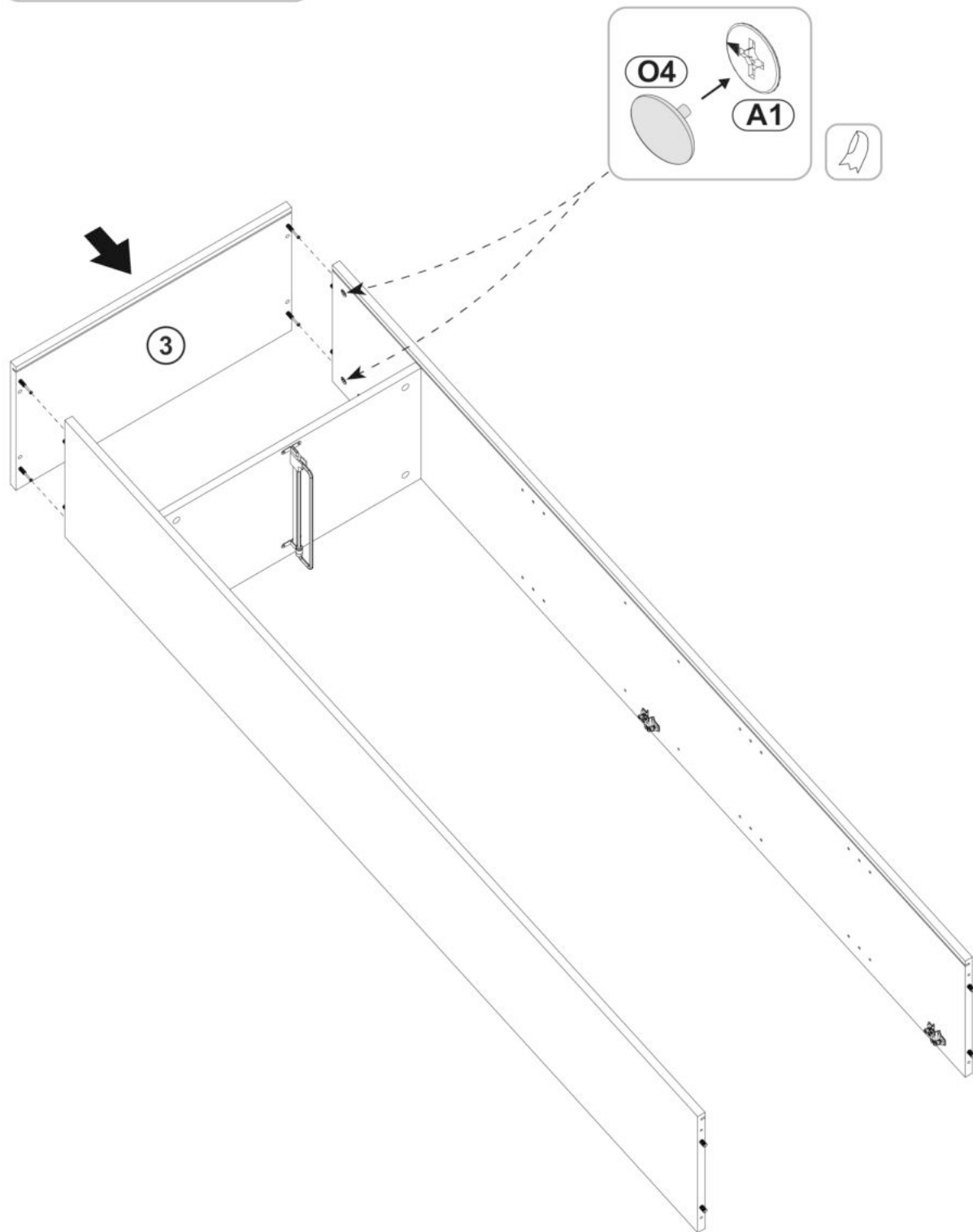

5

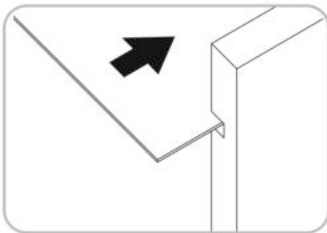
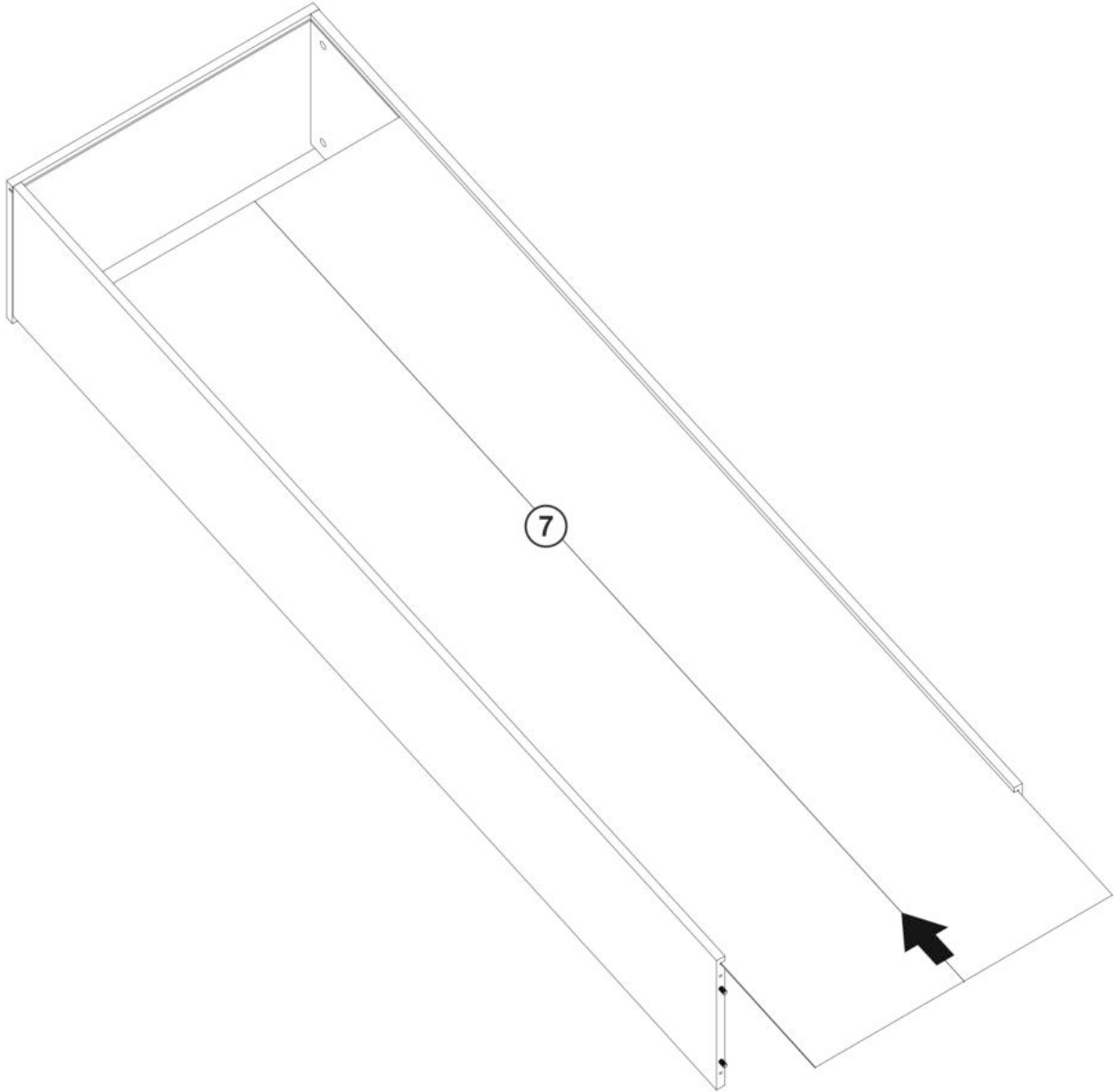
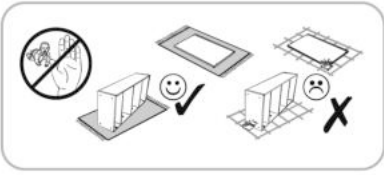

6

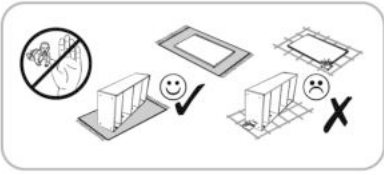

FA1
4mm x1

F3
6,3x50 x4

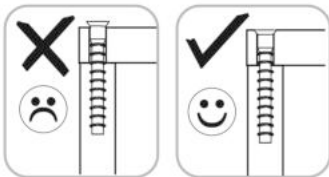
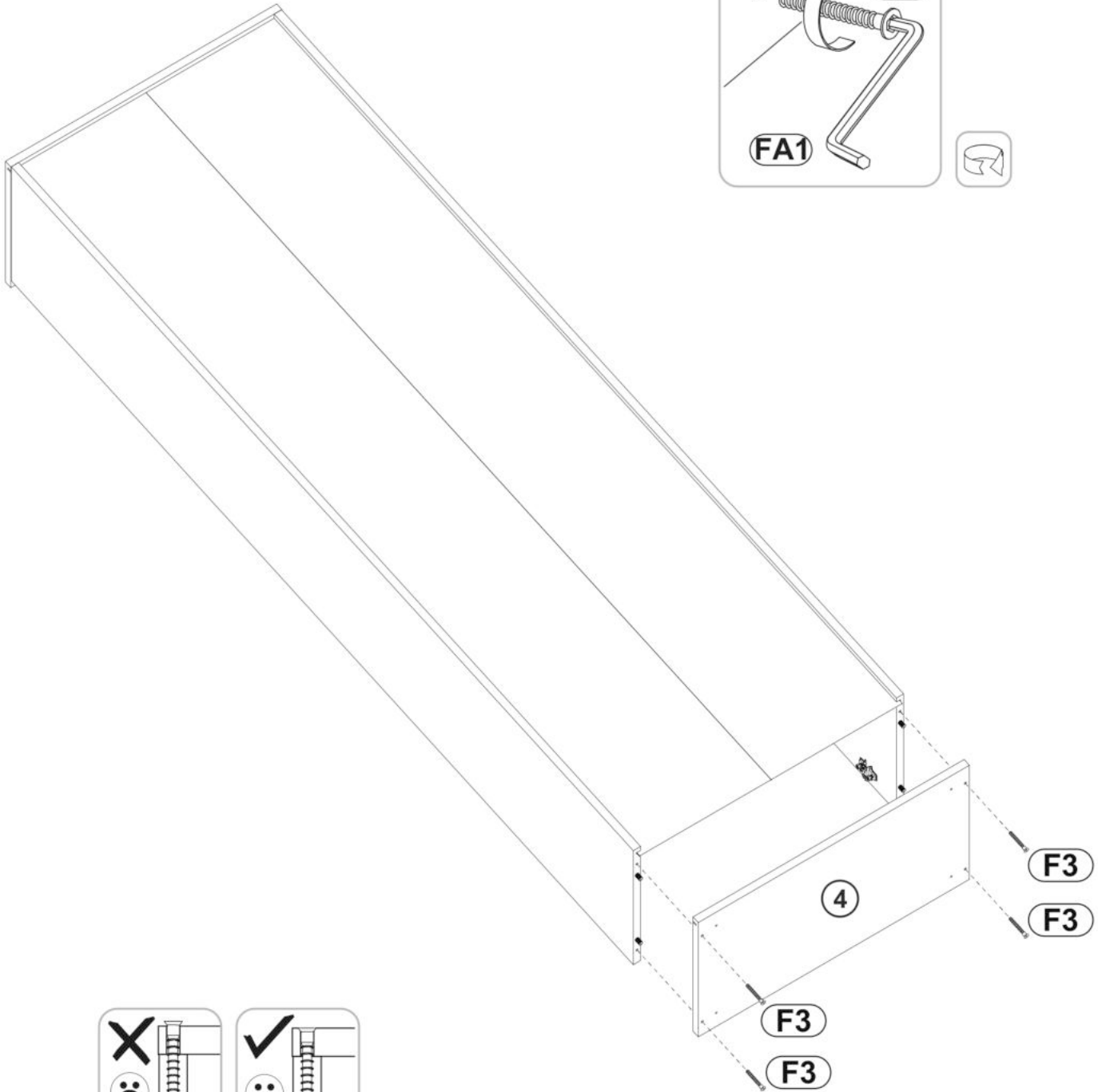
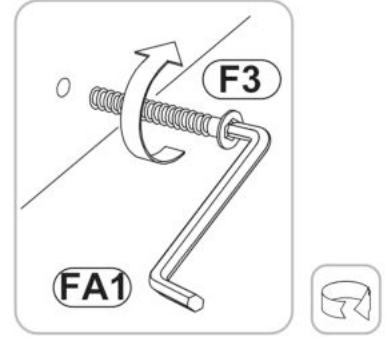

7

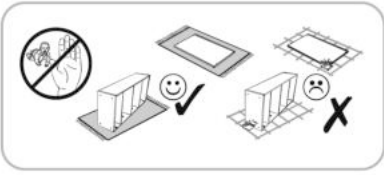

M1
10x10x15 x14

DA21
4,2x16 x4

P14
45x20 x4

D25
4x25 x4

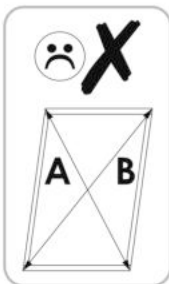
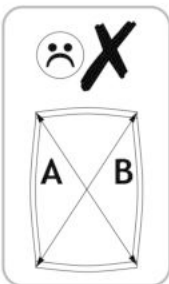
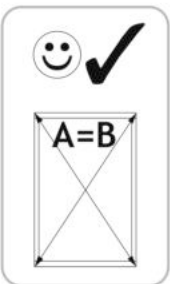
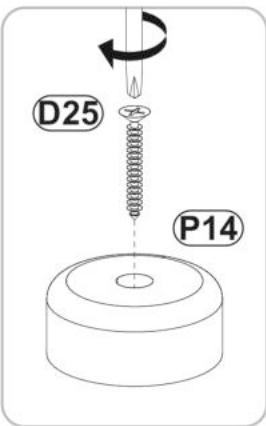
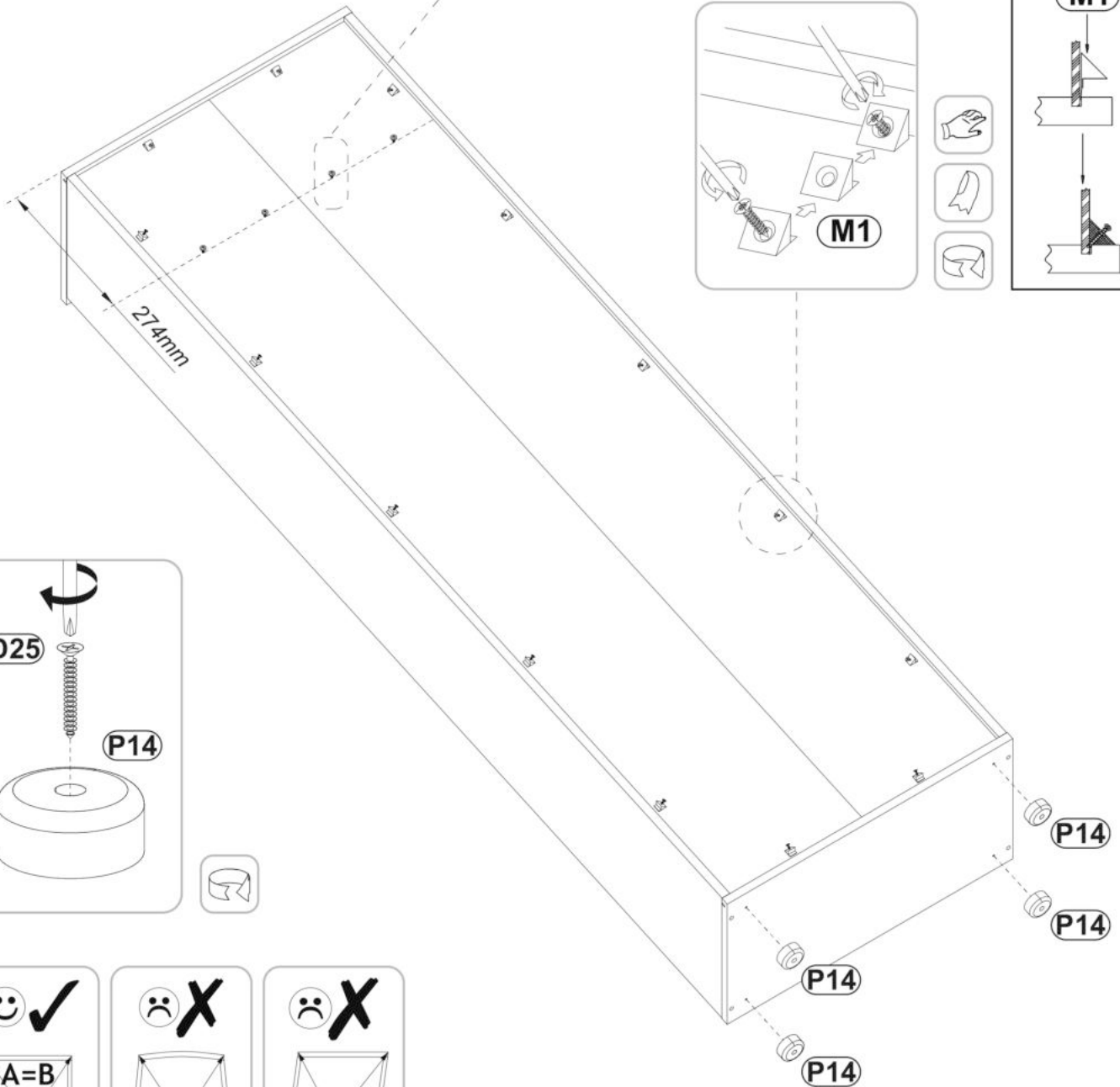
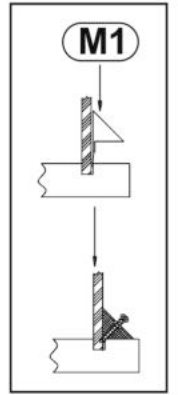
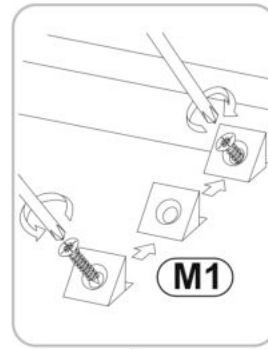
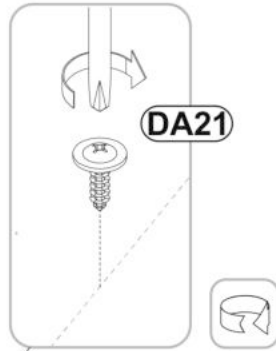
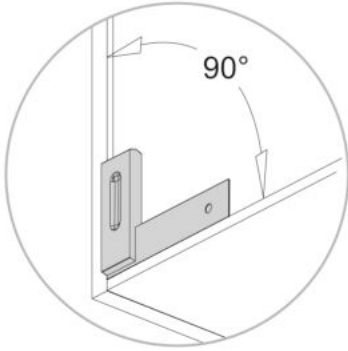

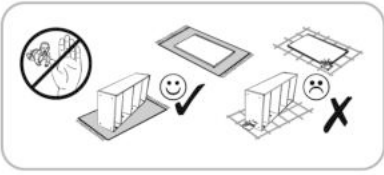

N1
Ø6 x16

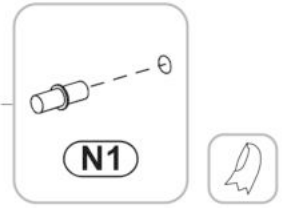
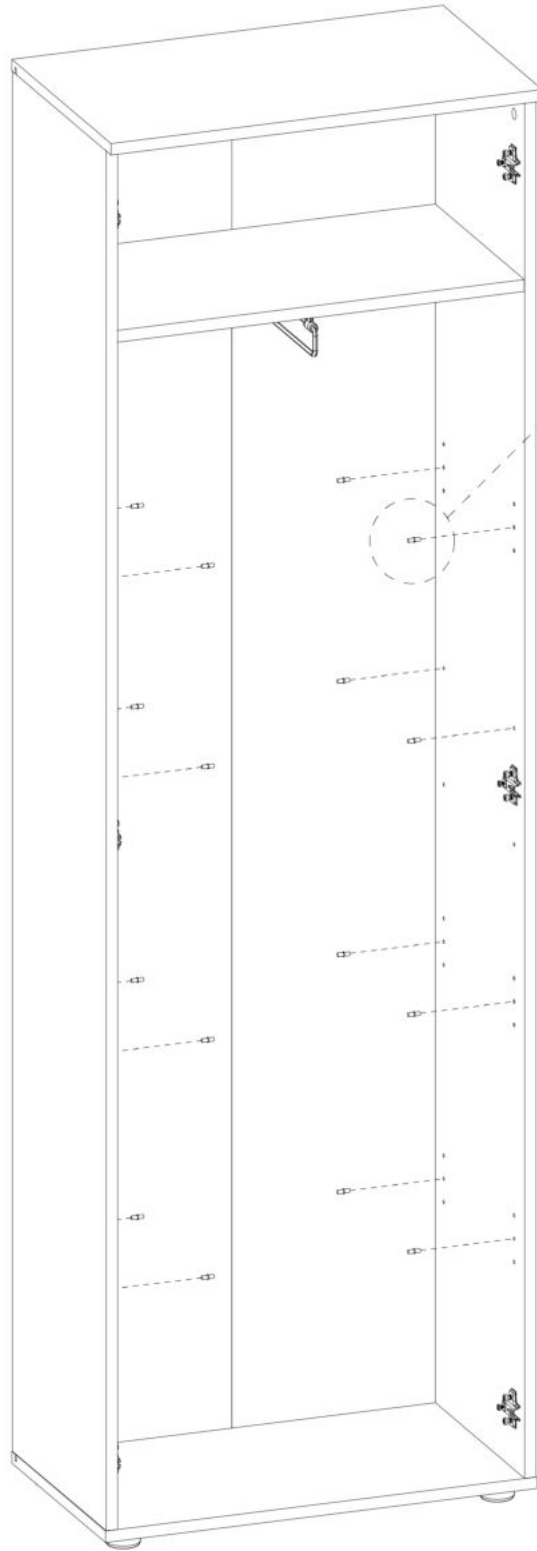

9

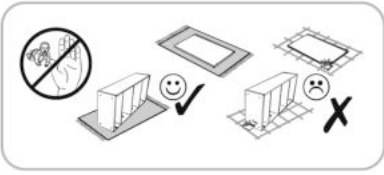

Y36
75x32x15 x1

Y37
8x50 x1

D11
3,5x16 x2

Y35
4,2x65 x1

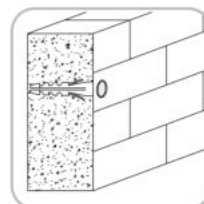
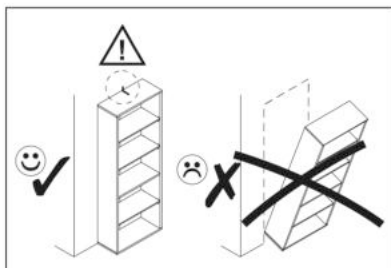
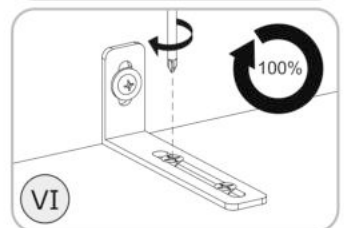
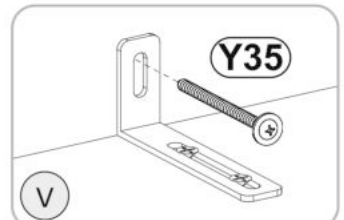
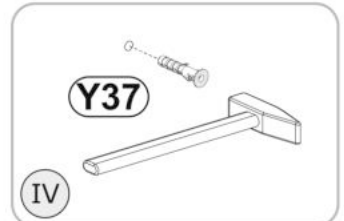
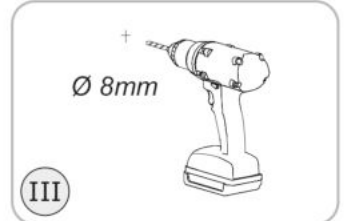
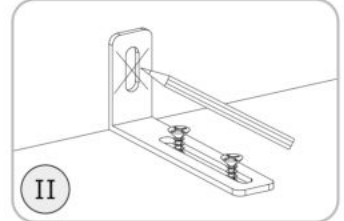
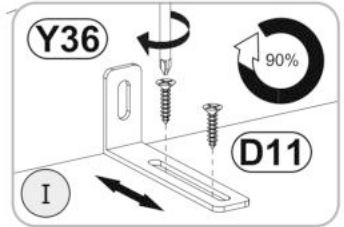
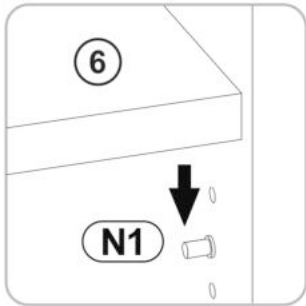
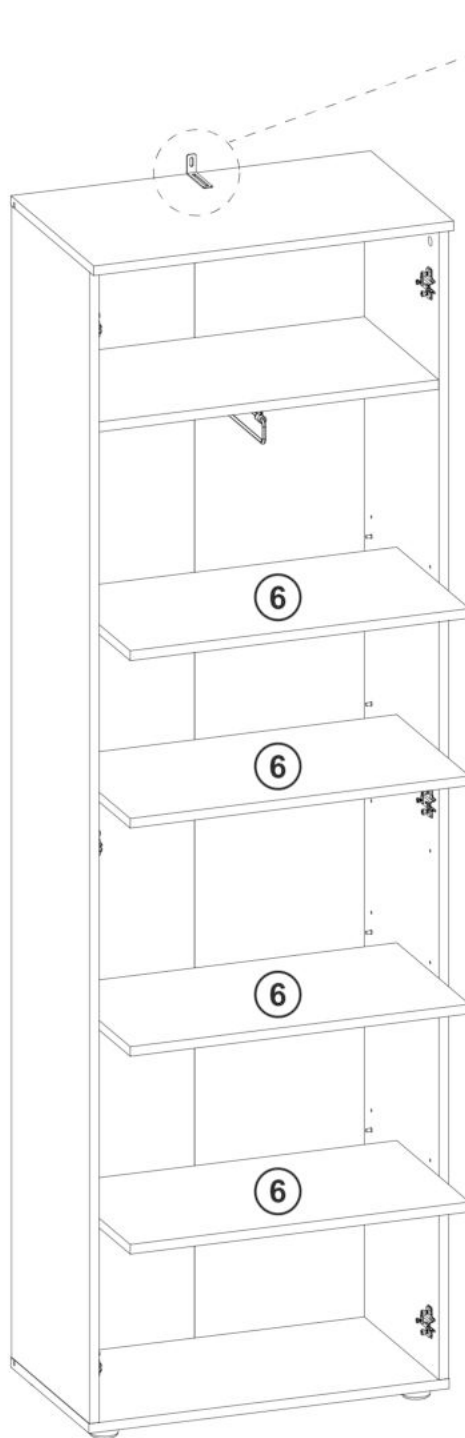

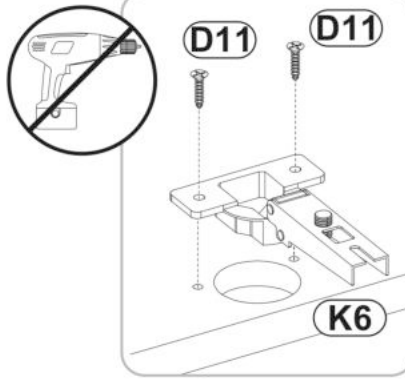
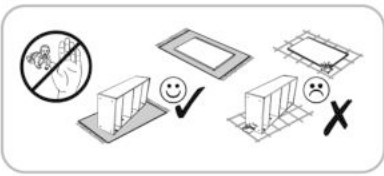

10



K6
Ø35  x6

D11
3,5x16  x12

DB2
4x25  x2

J65
128/148  x1

R10
Ø10  x4

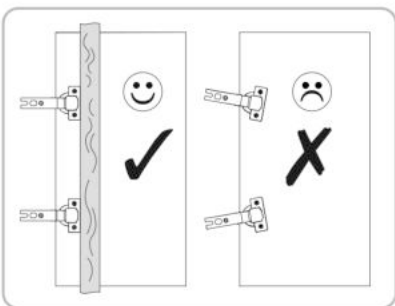
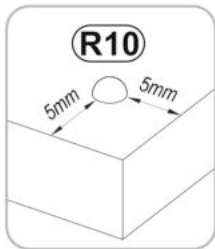
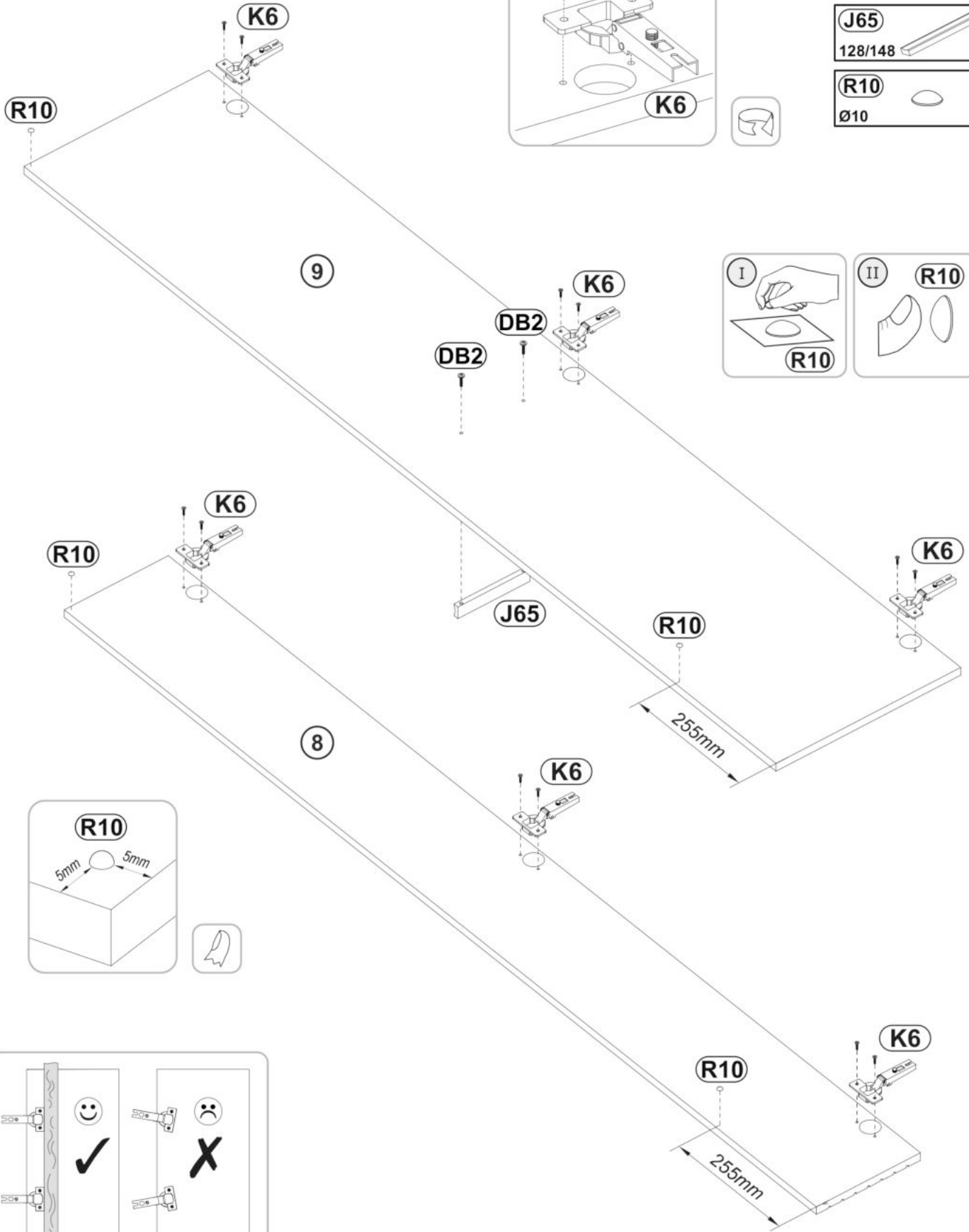

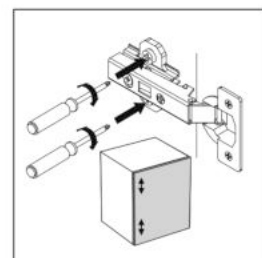
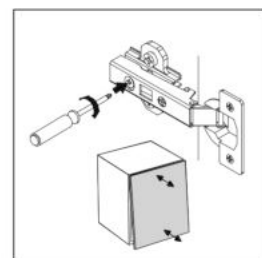
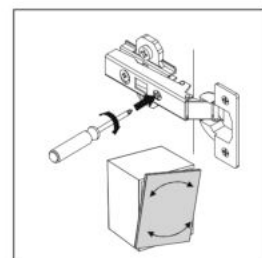
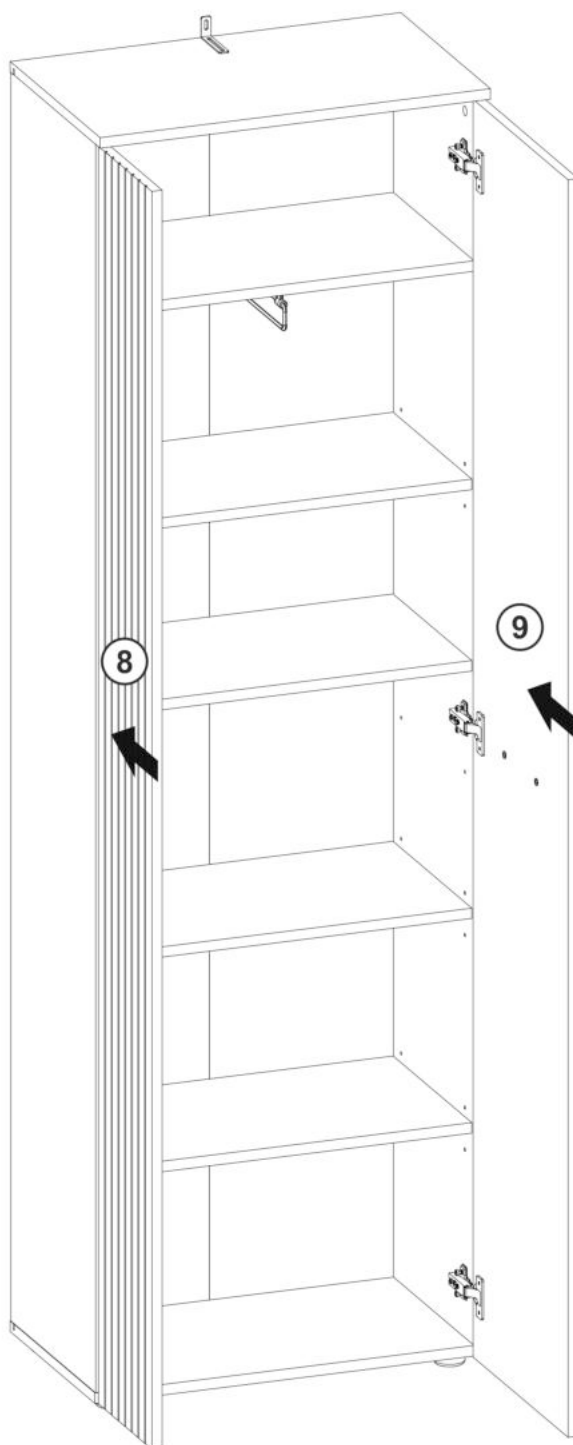
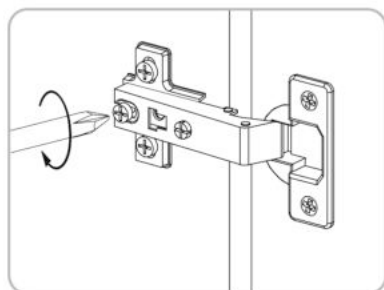
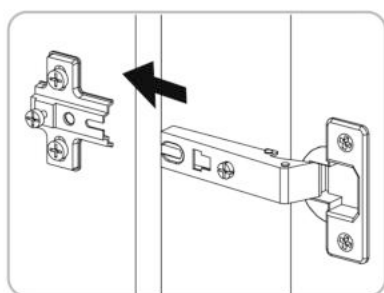
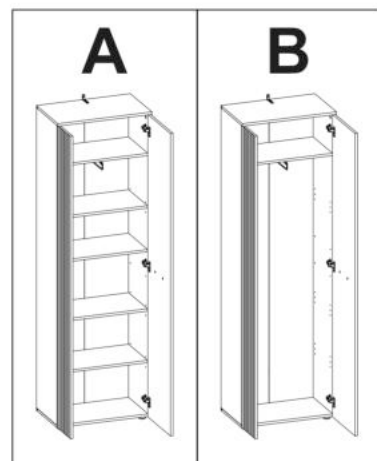
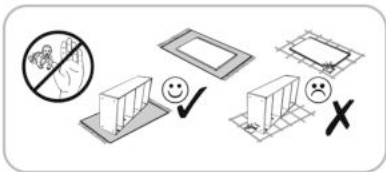

L

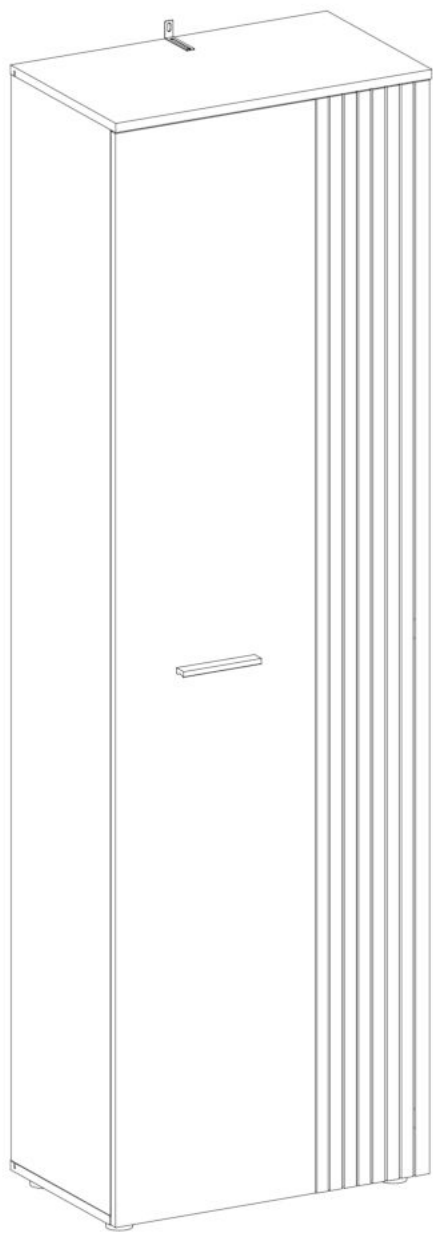

R

